

REAFS

RE-WIND DESIGN

MMXIX

RE-
Wind

DESIGN

ATLAS

Principal Investigators

Larry Bank
Jian-Fei Chen
Russell Gentry
Paul Leahy

Group Members

Angie Nagle
Benjamin Tasistro-Hart
Conor Graham
Emma Delaney
Fergal Gough
Franco Arias
Gerard Mullally
Heloisa Lemmertz
Jennifer McKinley
Matthew Nicholl
Niall Dunphy
Raj Suhail
Ruth Morrow
Tristan Al-Haddad

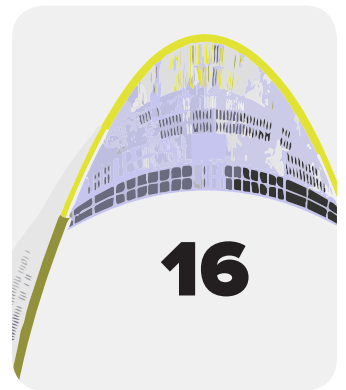
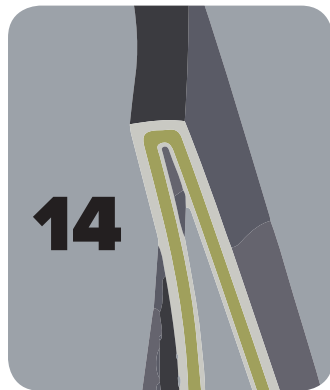
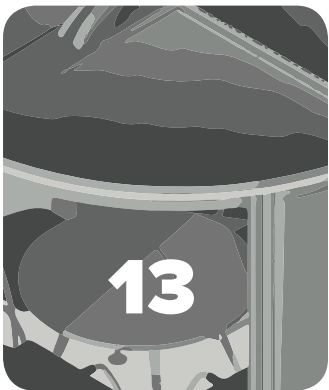
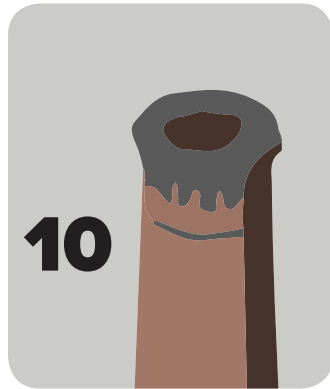
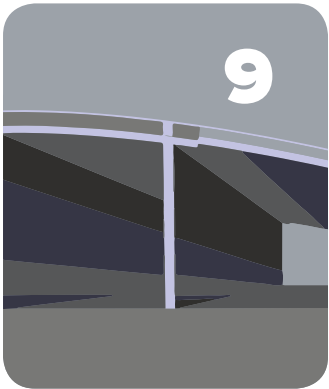
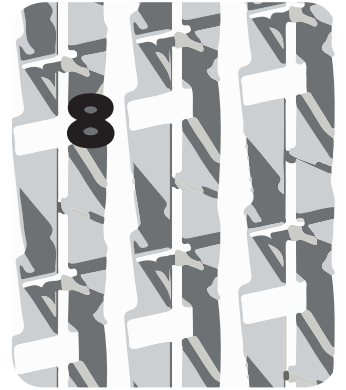
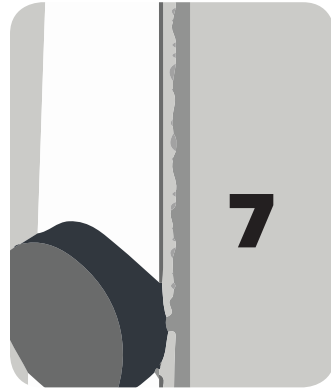
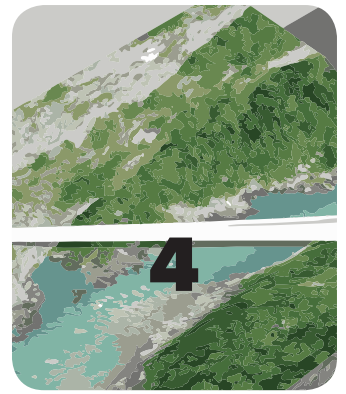
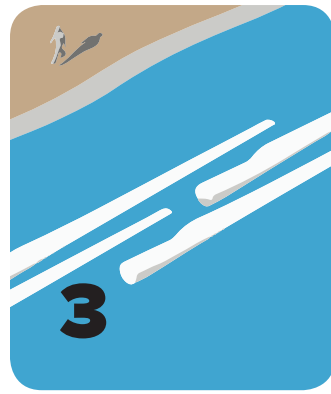
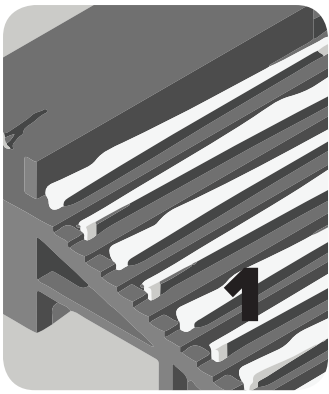

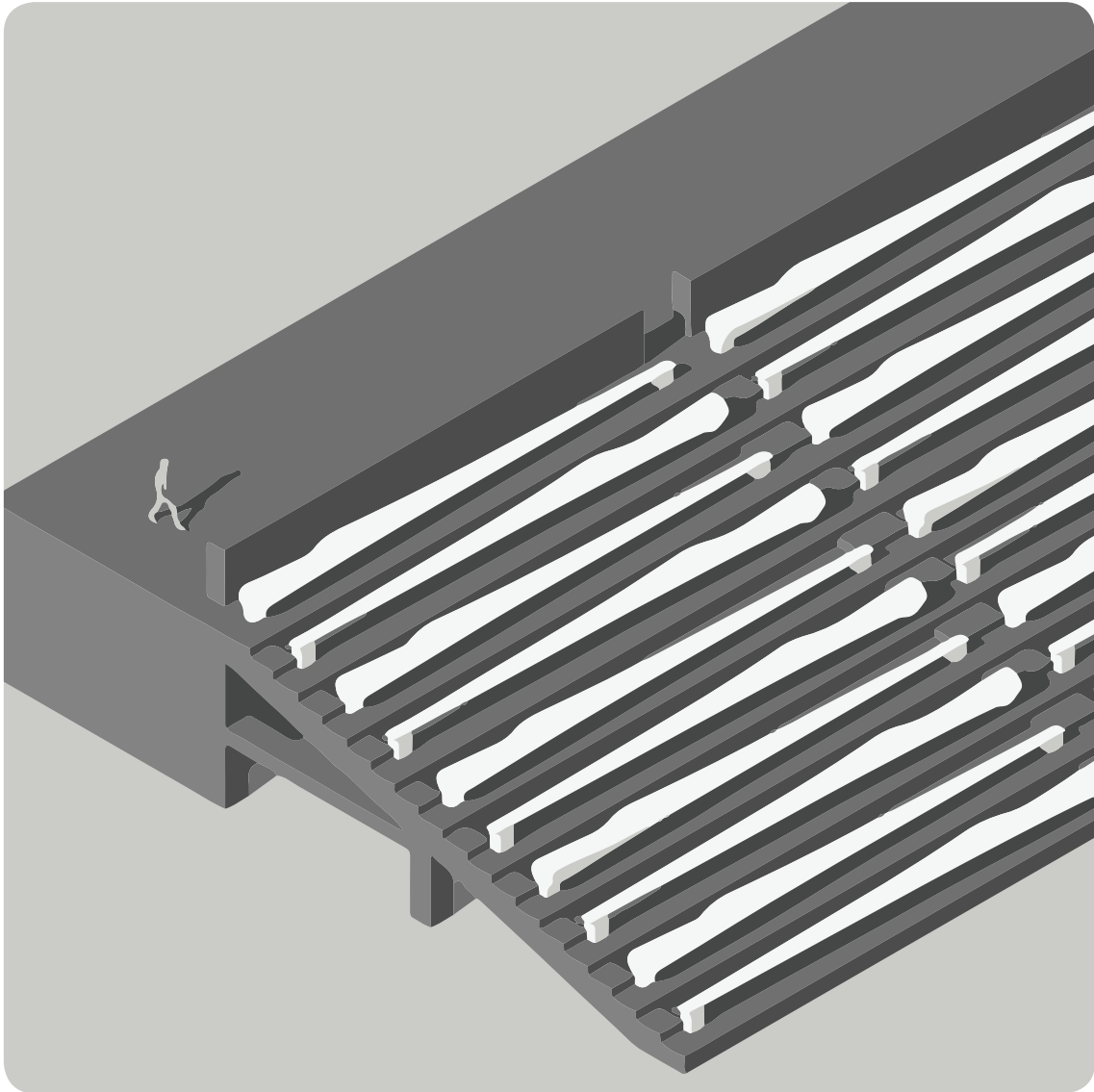

Bleacher

Long strips of blades or full smaller length blades could be used to construct bleachers (stands) for spectator seating at sporting, music or other events.

**Structure, horizontal,
durable**

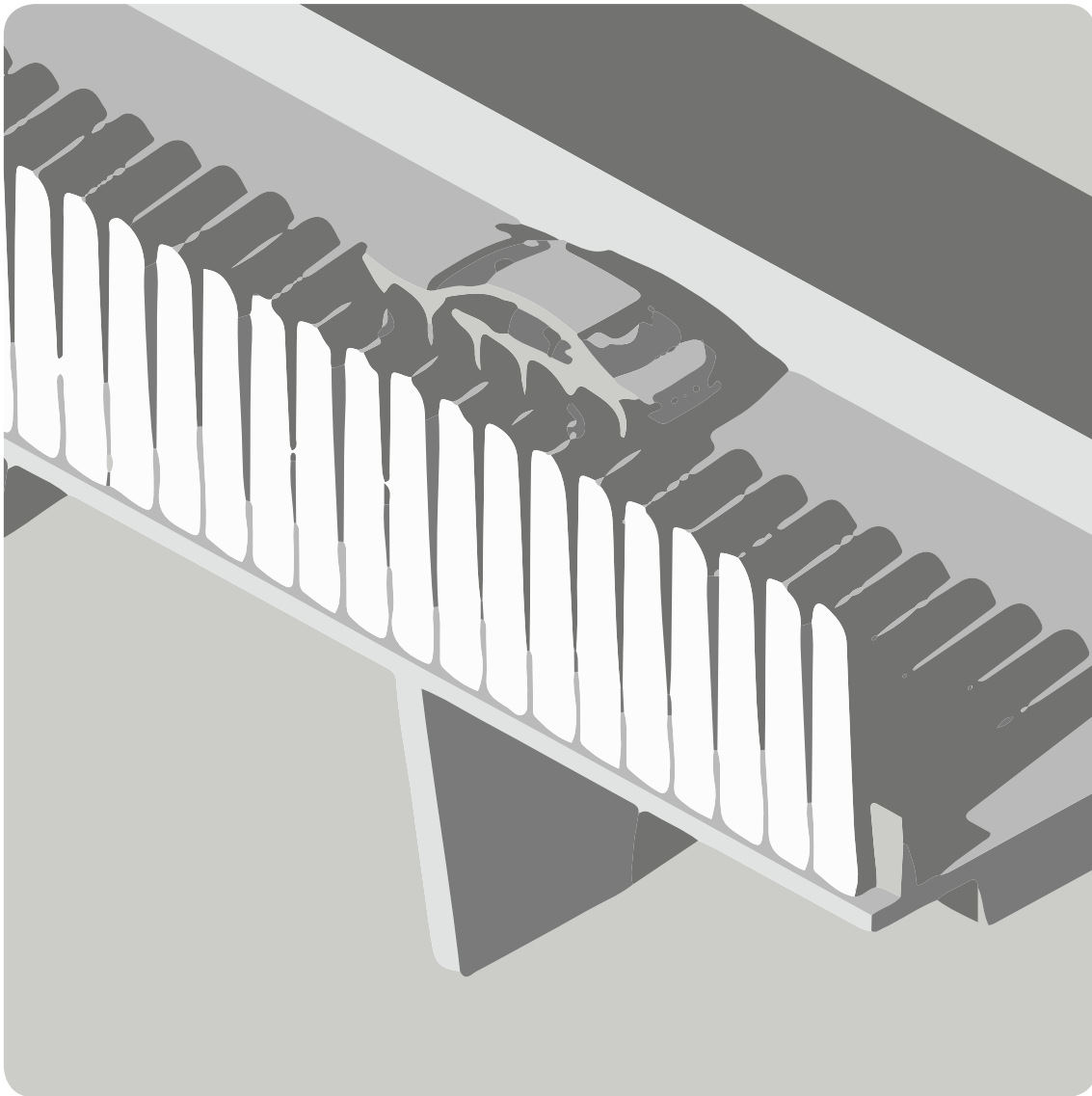

Noise Barrer

Road and highway traffic noise is one of the worst noise pollution problems worldwide. As urban and residential sprawl encounters heavier and heavier traffic loads on nearby roads and highways, residents and communities are demanding better noise abatement.

Acoustics, mobility, shield

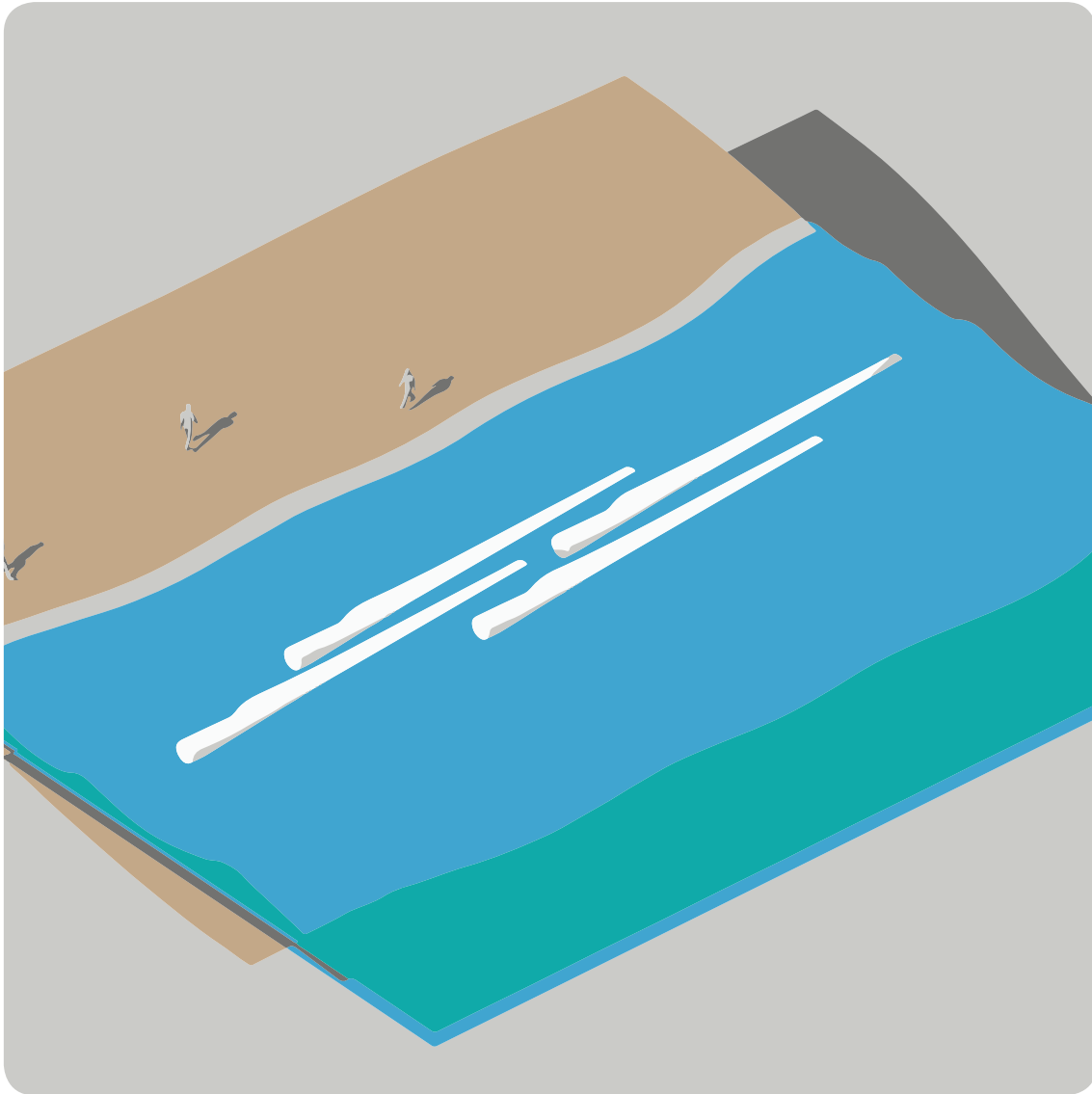

Wave Atten- uator

Structure, embedded or floating

Blades or long strips could be either embedded on coastlines to attenuate braking waves or could be floated horizontally to attenuate wave swells further offshore.

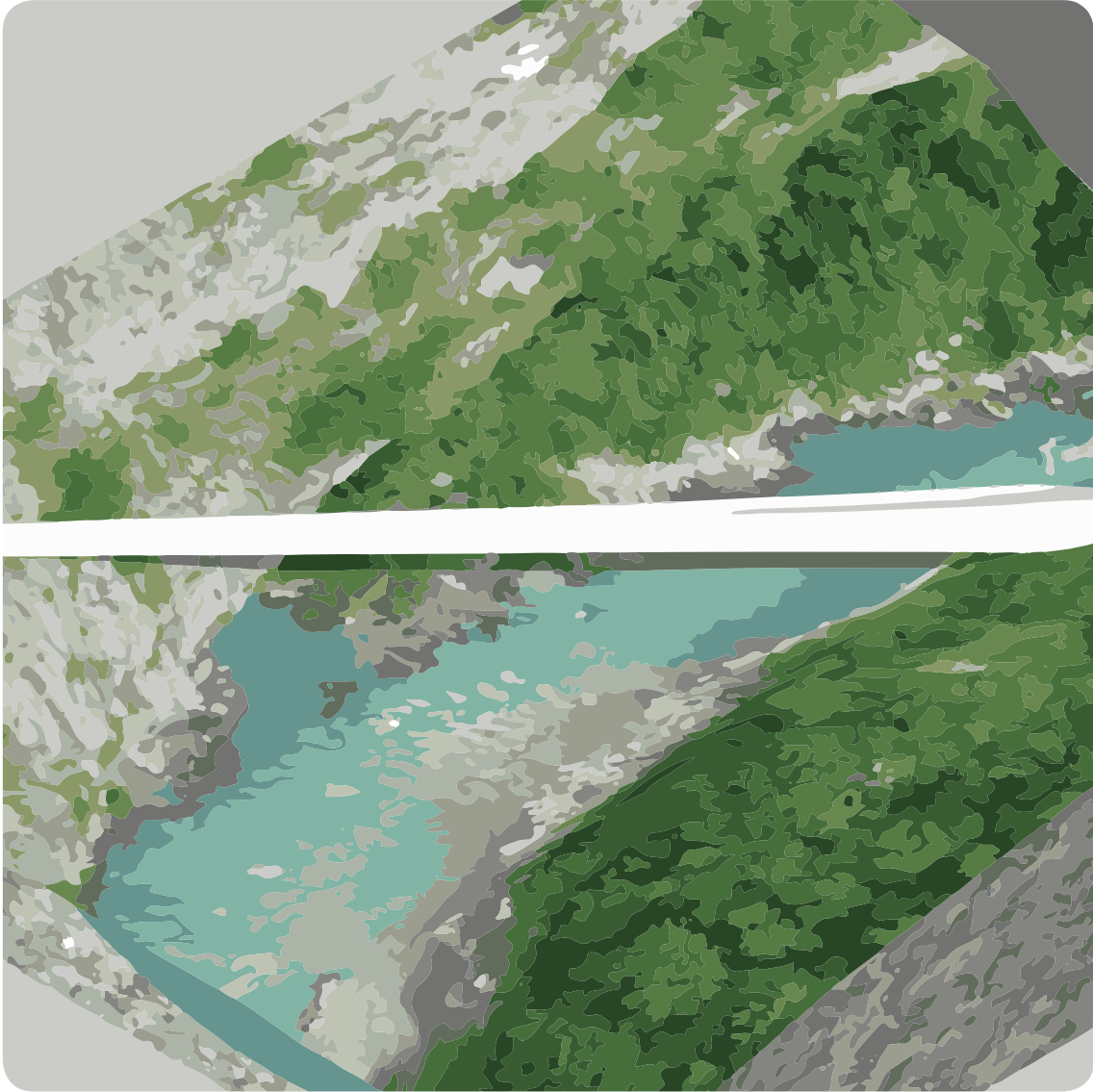

Bridge

One or more windblades are split down the seam originally produced. These halves are arranged in plan so that the tapers are opposite and so the blades nest close together. The webs of the blade are left intact and holes are drilled into them to promote composite action between the concrete and the blades.

Connection, urban landscape, mobility, bridge

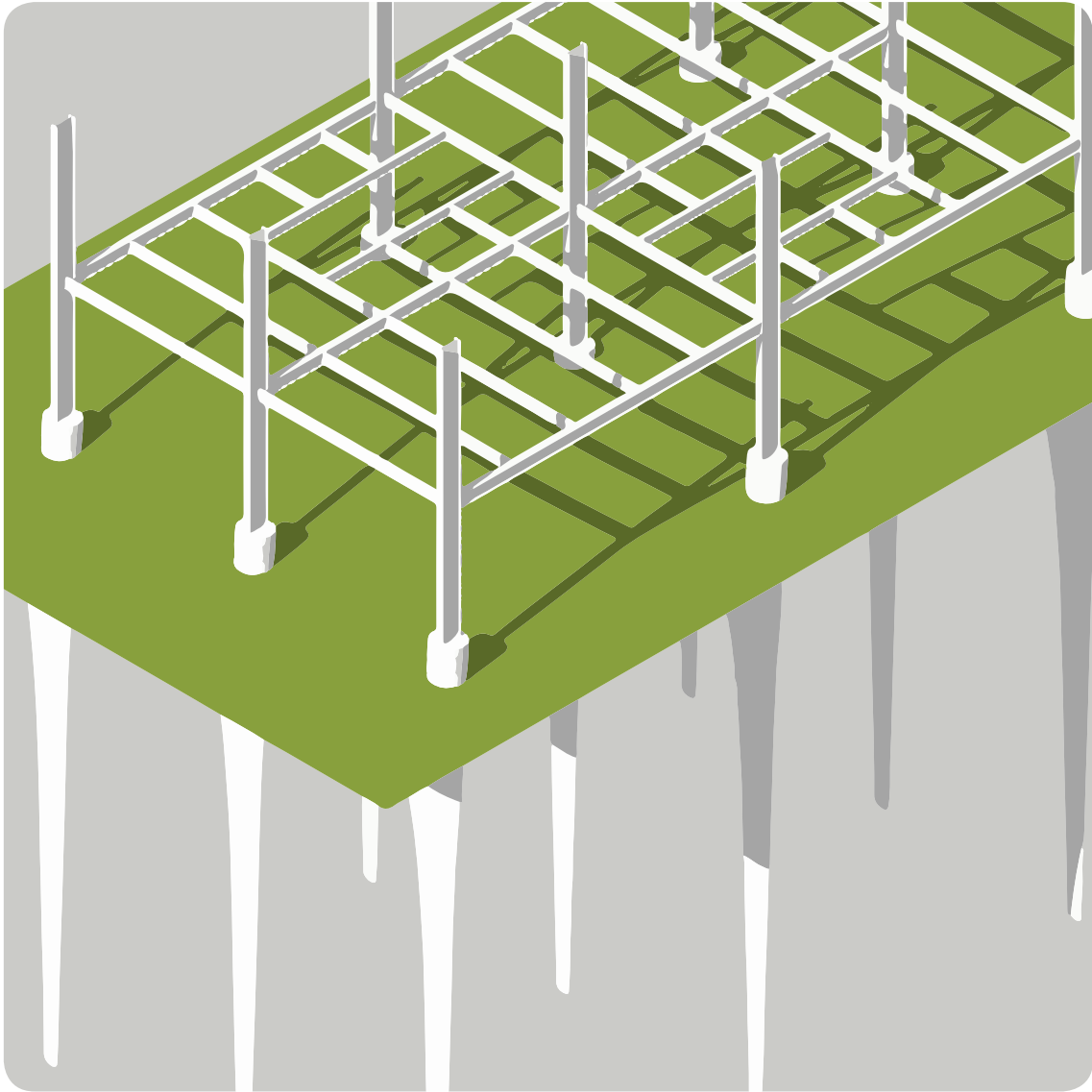

Pile

The blade would be driven down through the earth to create a stable pile foundation. Concrete could fill the blade and be encased.

**Foundations, structure,
inert**

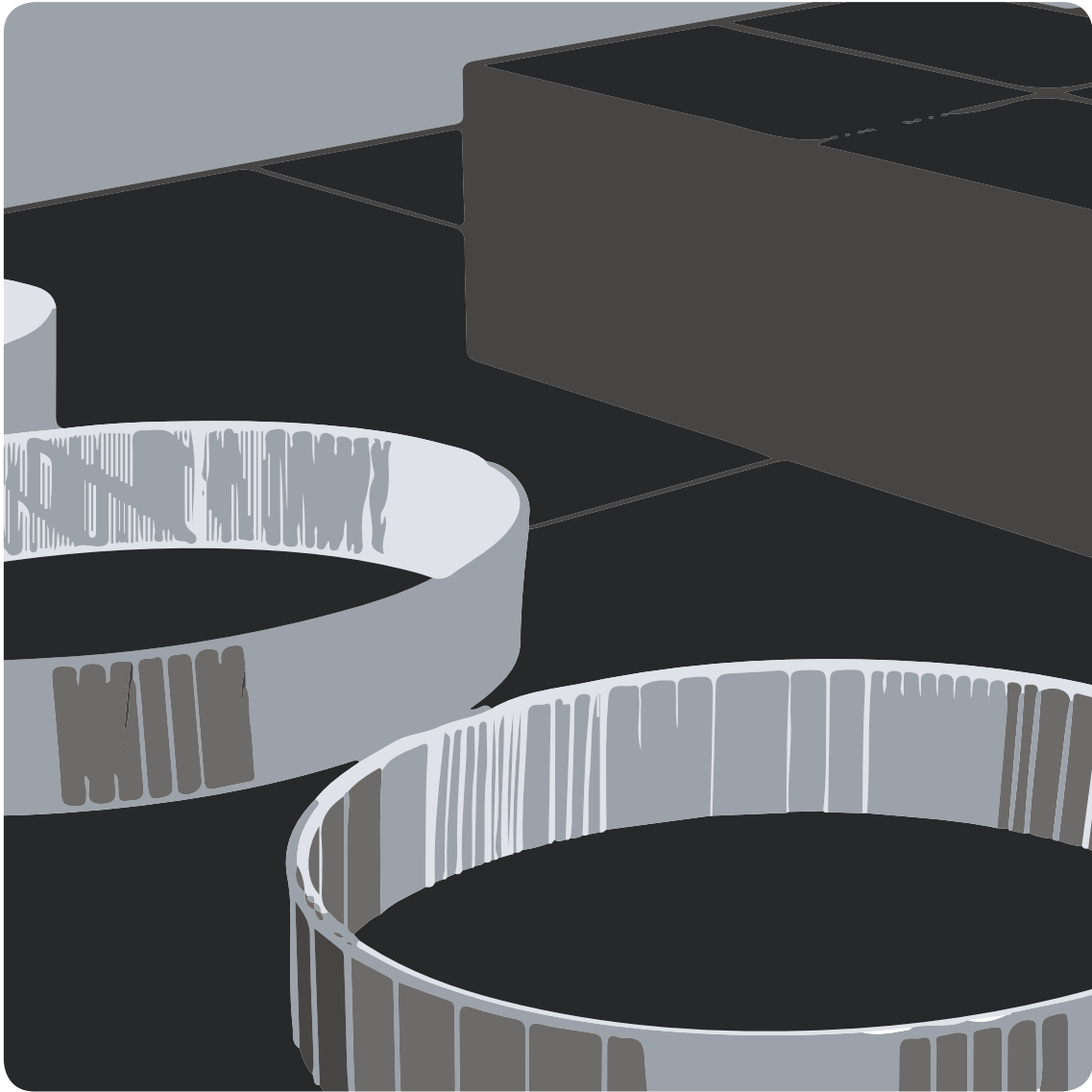

Tank

**Root section, surface,
waterproof, inert,
interface with existing
infrastructure.**

Root profiles could be reconstituted to create various sizes of tanks, these could be buried underground and serviced with existing plumbing infrastructures. Given the properties of the turbine blade, the walls of the tank would be waterproof.

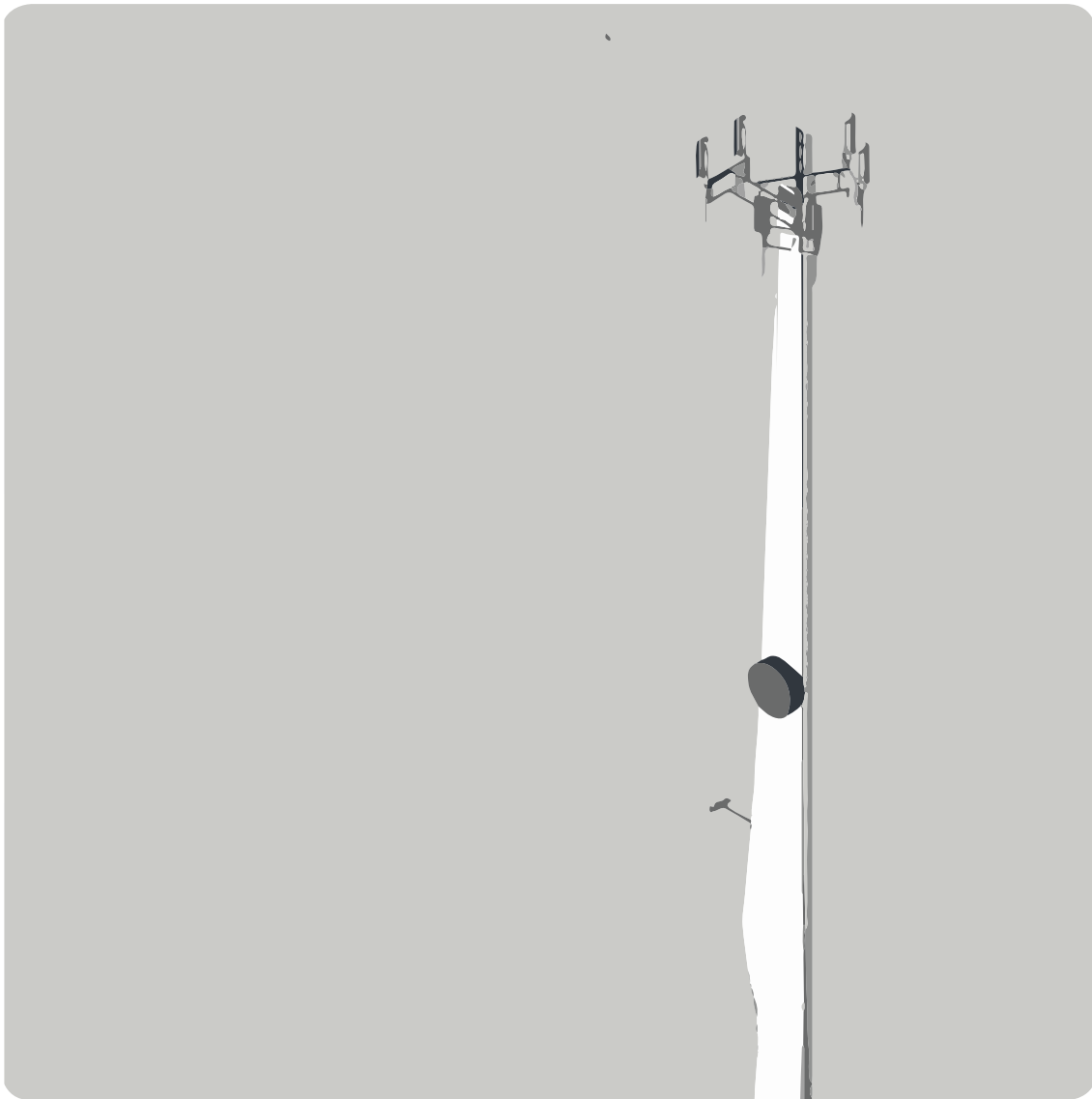

Cell Tower

**Structure,
electromagnetically
transparent, strong under
wind loading**

***Blades would be
embedded vertically
in the ground to
create cellular
towers. Since FRP is
electromagnetically
transparent the
transmitters could be
placed inside the section
and wiring would be
internal.***

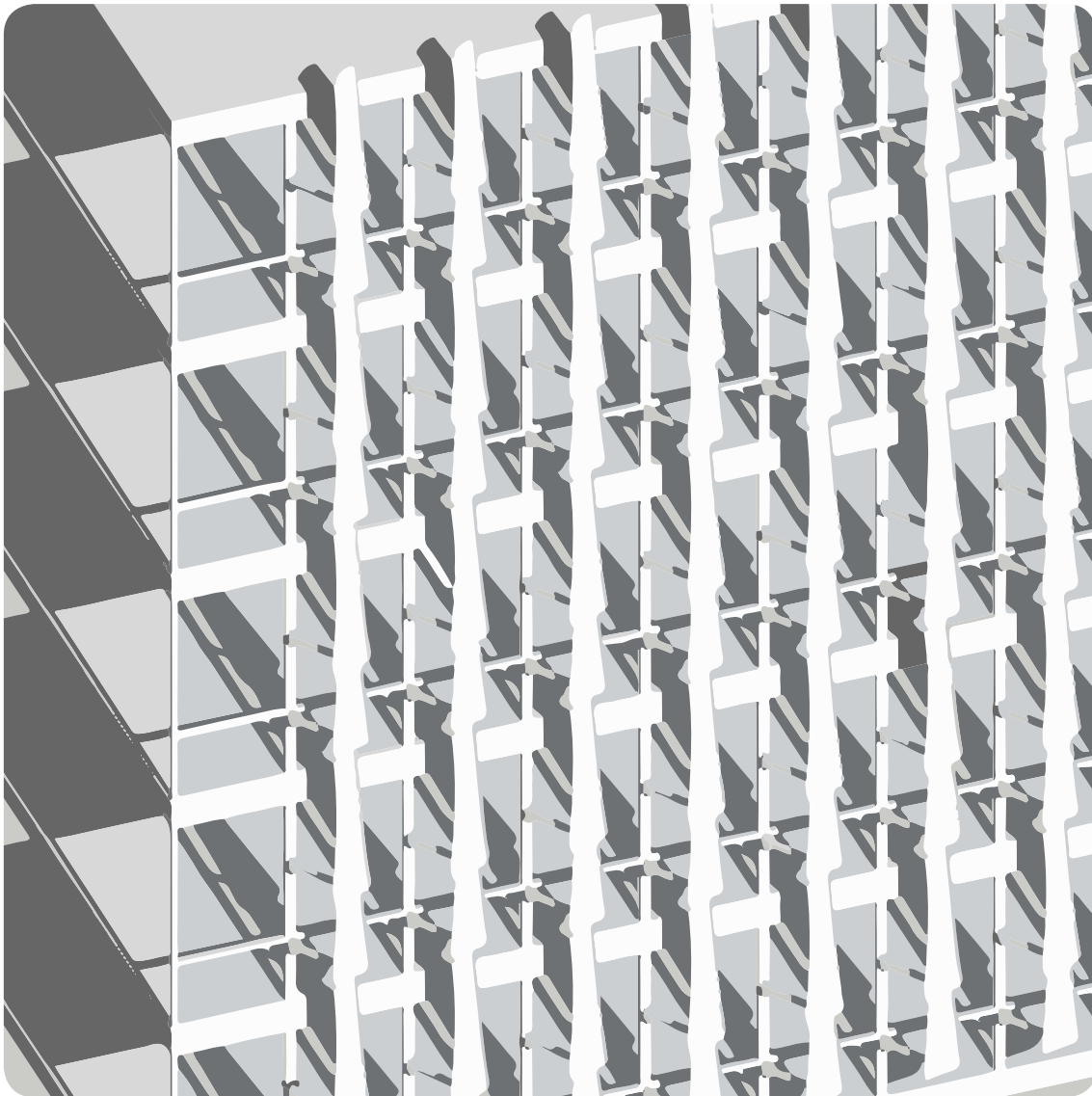

Facade

Profiles would be cut out of blades in order to create a range of wall panel sizes. The material could be cut in order to create a series of openings. Thermal layers could be bonded to the already composite material.

**Separation, Acoustics,
Thermal performance,
texture, relief, openings**

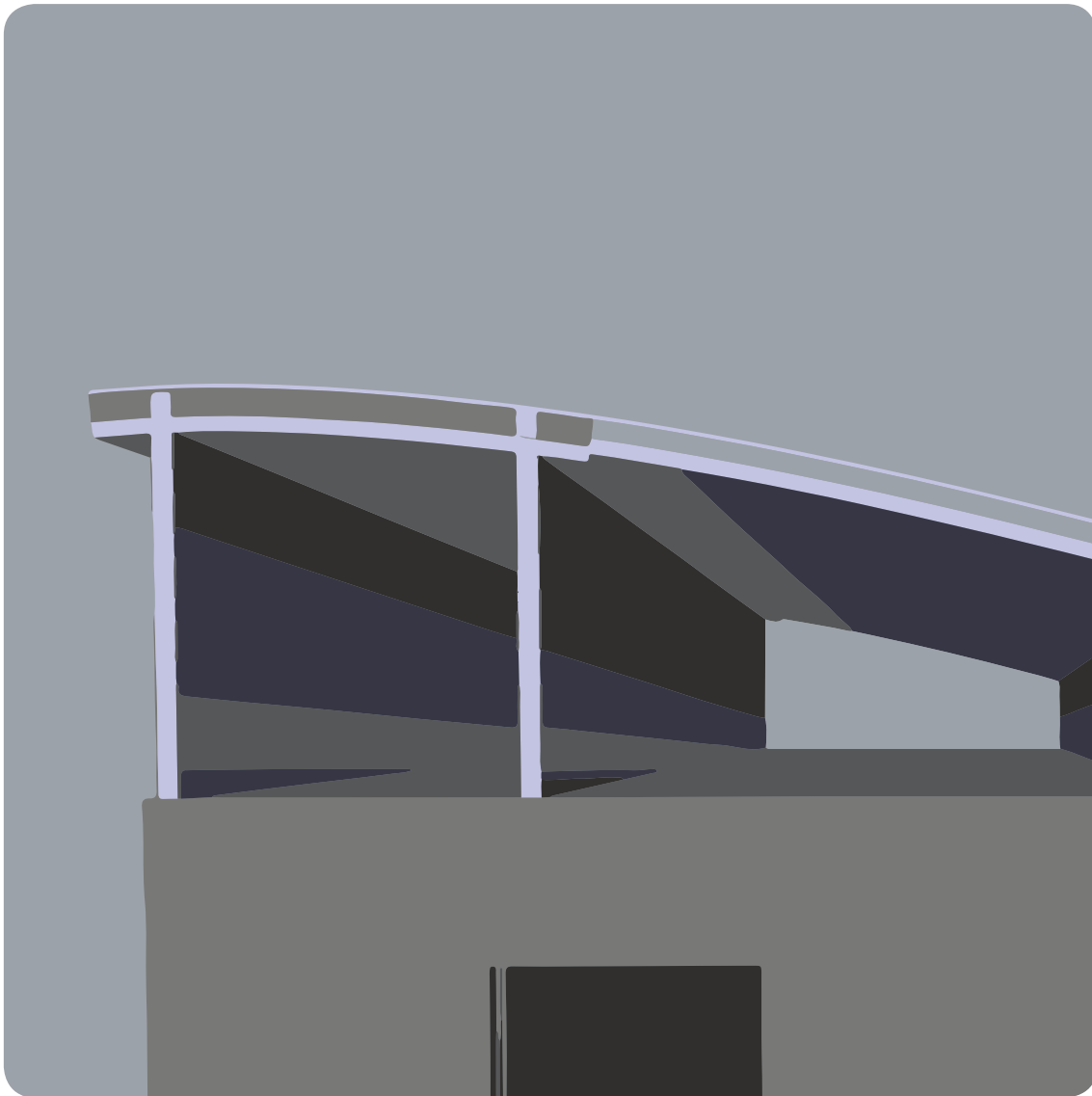

Roof Truss

Profiles of the blade could be used to create complete roof sections, watertight surface. In in pieces smaller sections could act as trusses interfacing with other roofing materials.

**Double curve profiles,
load bearing capacity,
structure, interface with
other materials**

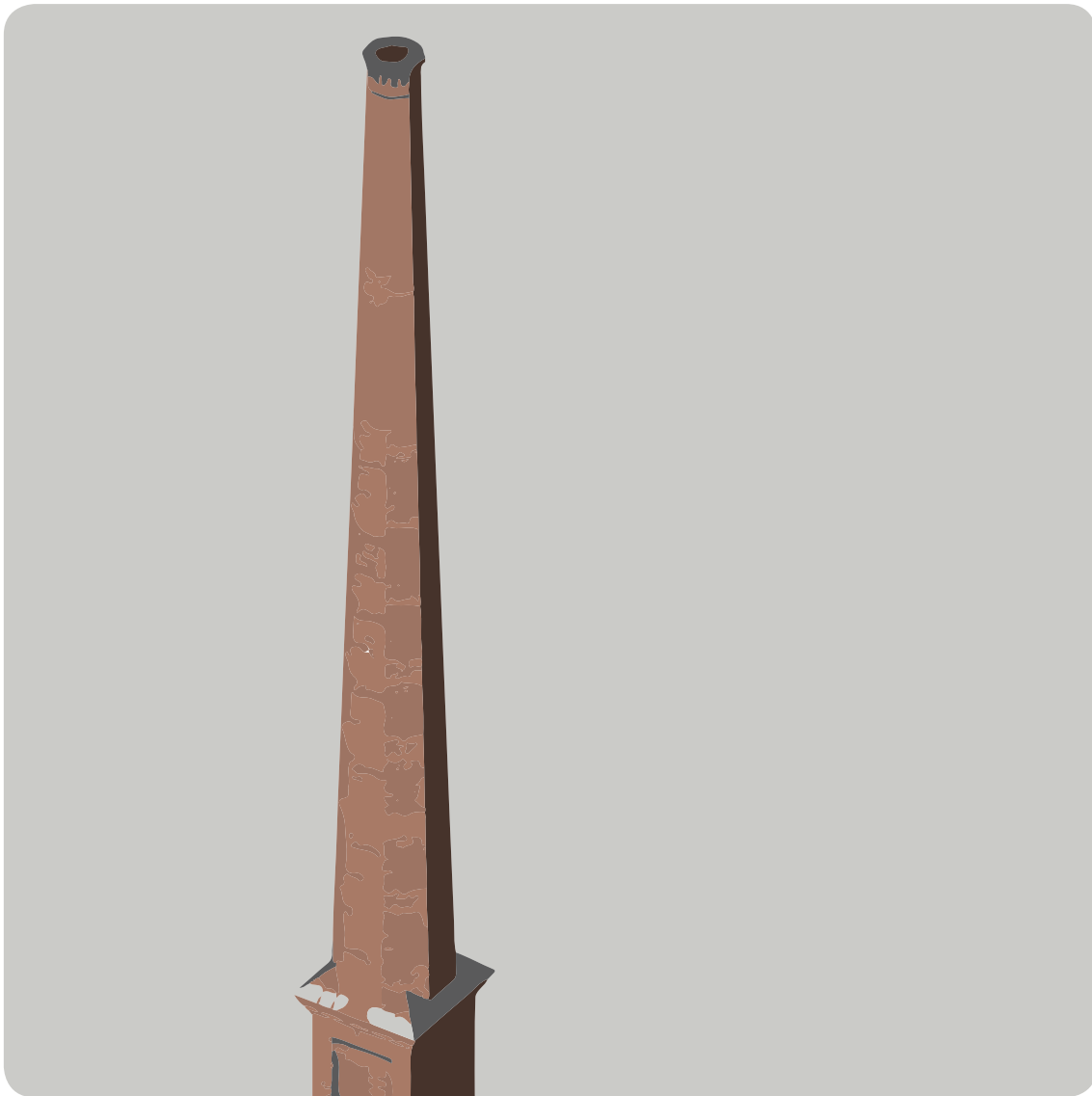

Chimn ey Liner

Full blades could be used as chimneys or as interior liners for concrete/brick industrial chimneys. The material would be cut out in strips and to line chimneys. The thermal properties of the blade could be exploited to further the lifespan of the chimney. Heat resistance may be an issue.

**Thermal performance,
longevity, melting point,
ease of maintenance**



Geo Reten- tion

Can be used to hold back earth for a range of applications across commercial or domestic construction sites. Size of blade can vary depending on required application.

**Stackability, interlocking,
load bearing capacity,
length of span**

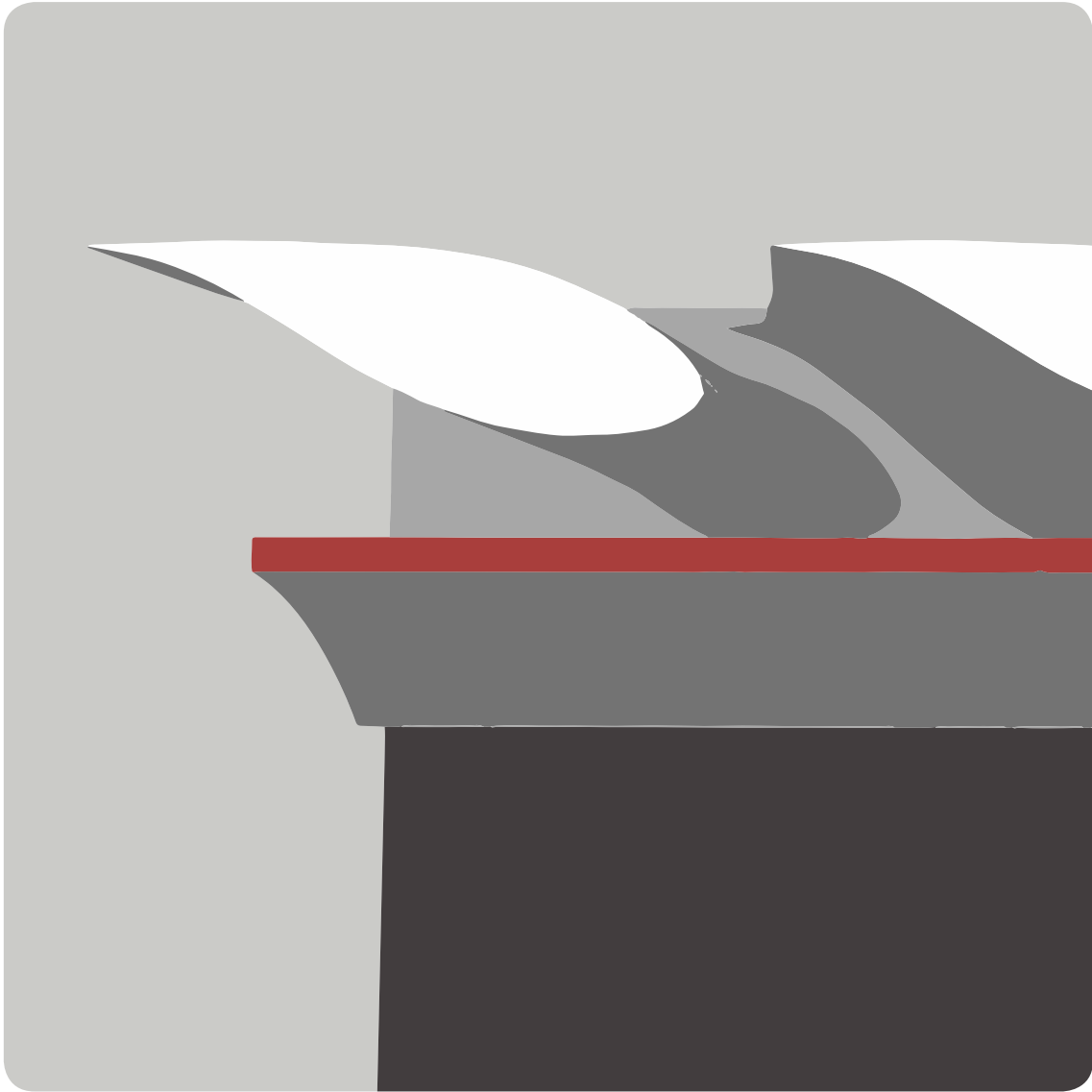

Louver

Blades cut to length can be deployed to service a range of ventilation systems. Given its air foil geometry, air or even water can be channelled to maximum effect.

Acoustics, compatibility with other materials, size

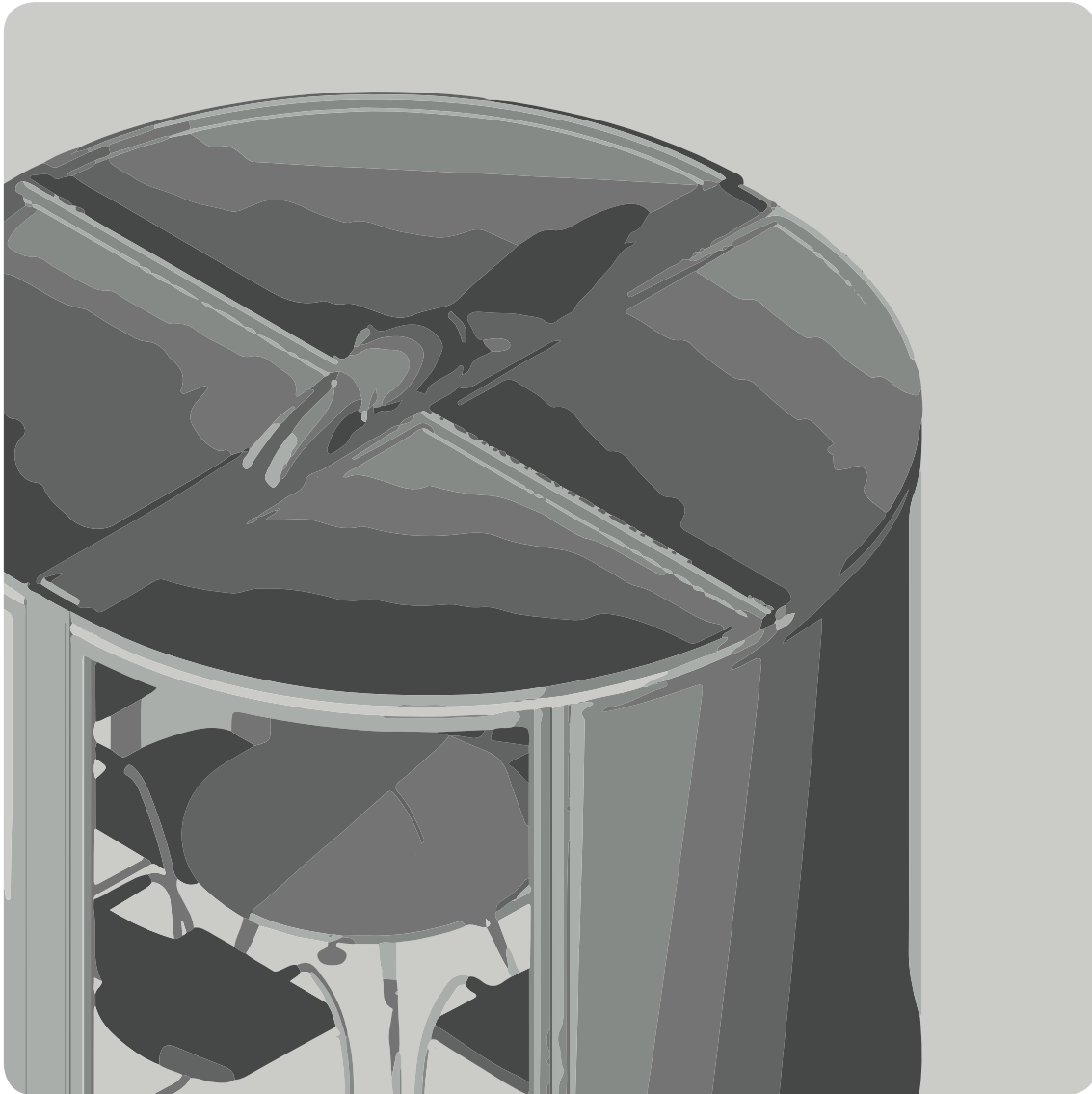

Quiet Pod

**Acoustics, compatibility
with other materials, size**

Pod units could be constructed from the root of the decommissioned turbine. The relative simplicity of the circular geometry provides opportunity to face and join with other materials.

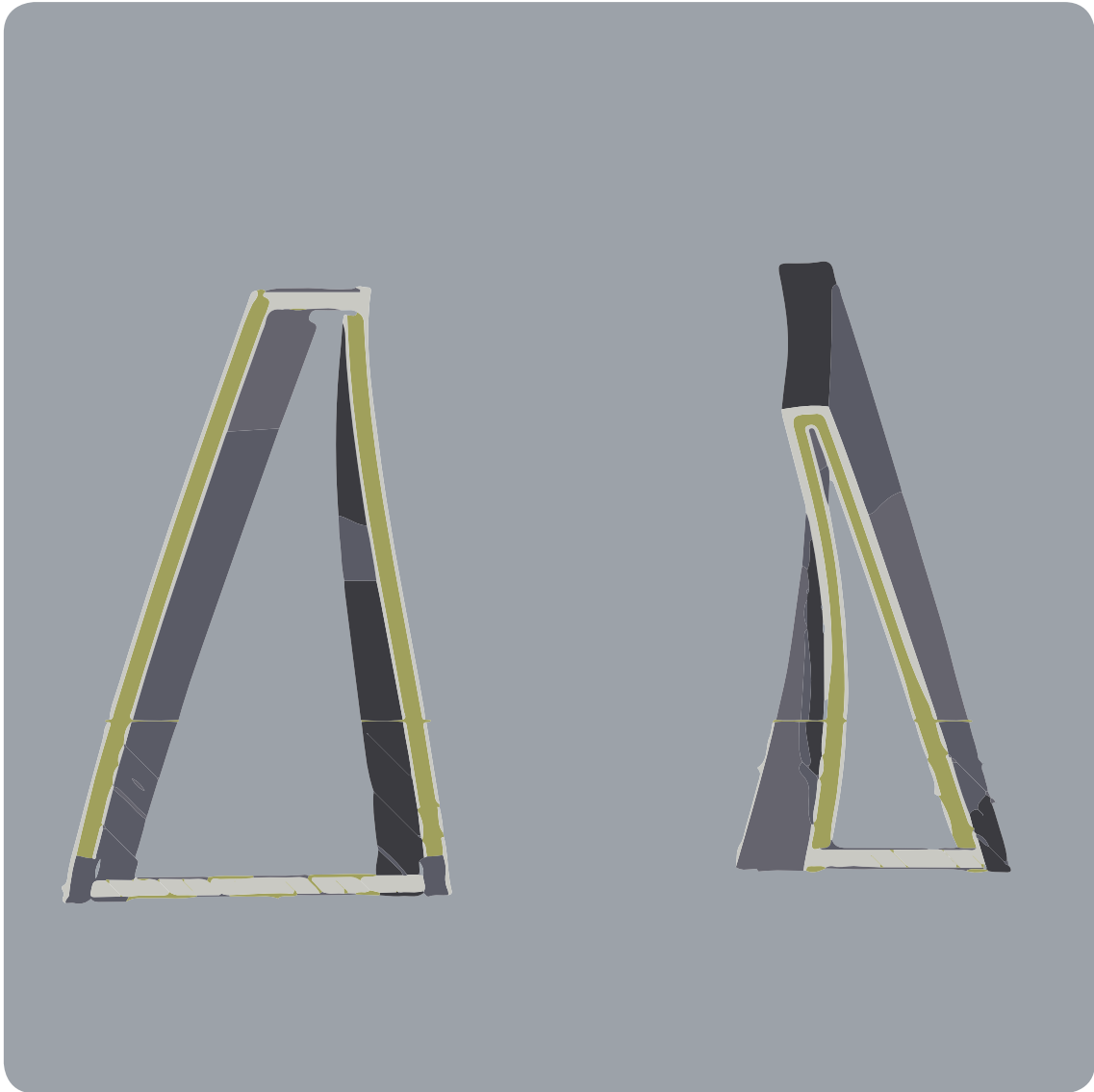

Barrier

Various profiles could be crafted into a range of responsive barrier systems that can be customised depending on specific requirements.

Double curve, acoustics, strength, durability

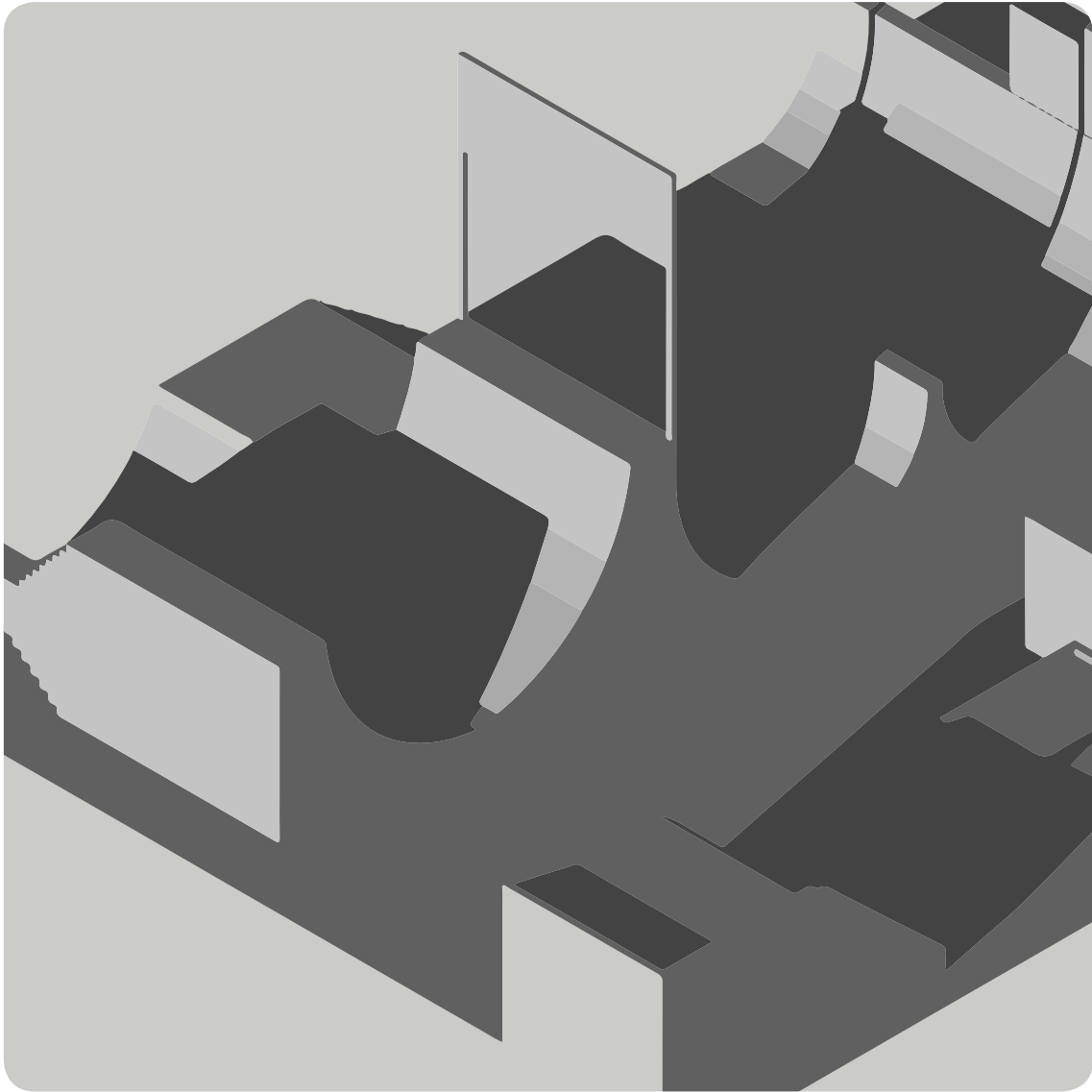

Skate

Park

Parts of the curved surfaces of blades are embedded in a contoured landscape to create a skate part - some concrete work also needed.

Double curve profiles, load bearing capacity, surface friction

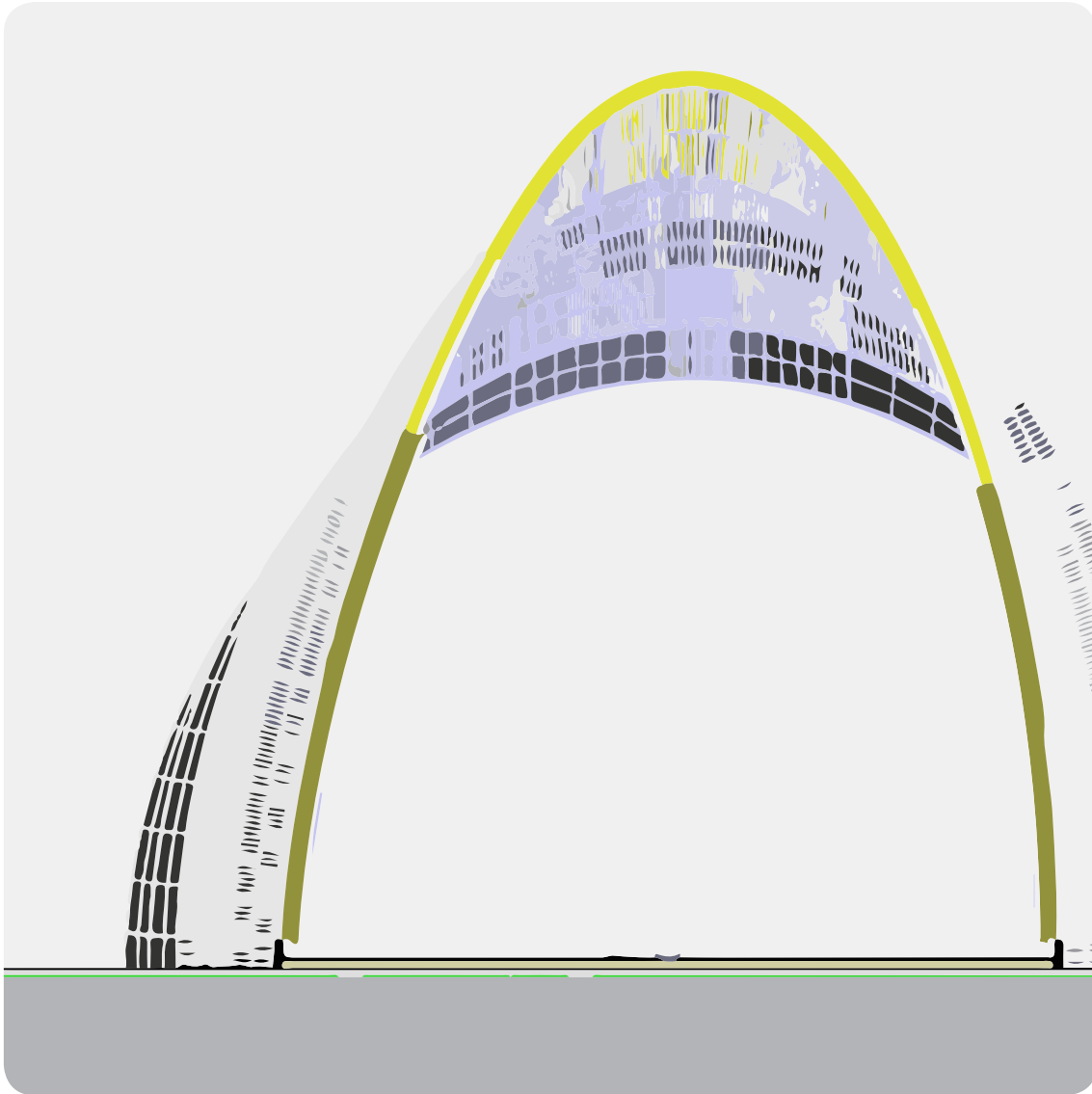

Vault

Large half leading edge section with shear webs removed used as a barrel vault for storage or recreation structures (park shelter).

Archway, embedded or supported

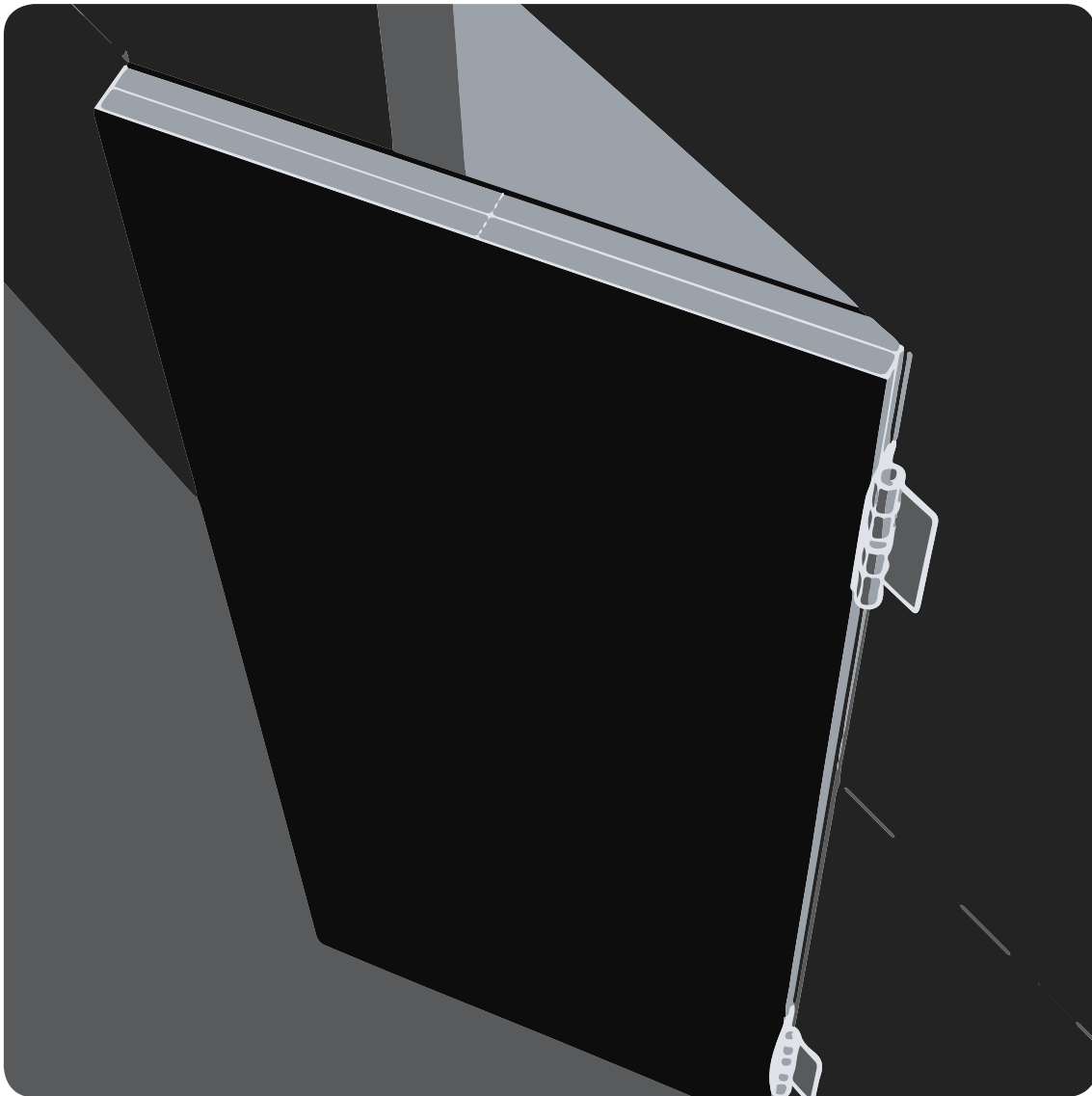

Door

**Small parts, compatibility
with hinge, decorative,
durable, acoustic**

***Web parts are the only
flat parts of the blade
and could be used
for many commodity
items requiring flat
sections. For housing
can be used for doors
and window shutters
for permanent or
temporary protection
against wind/rain.***

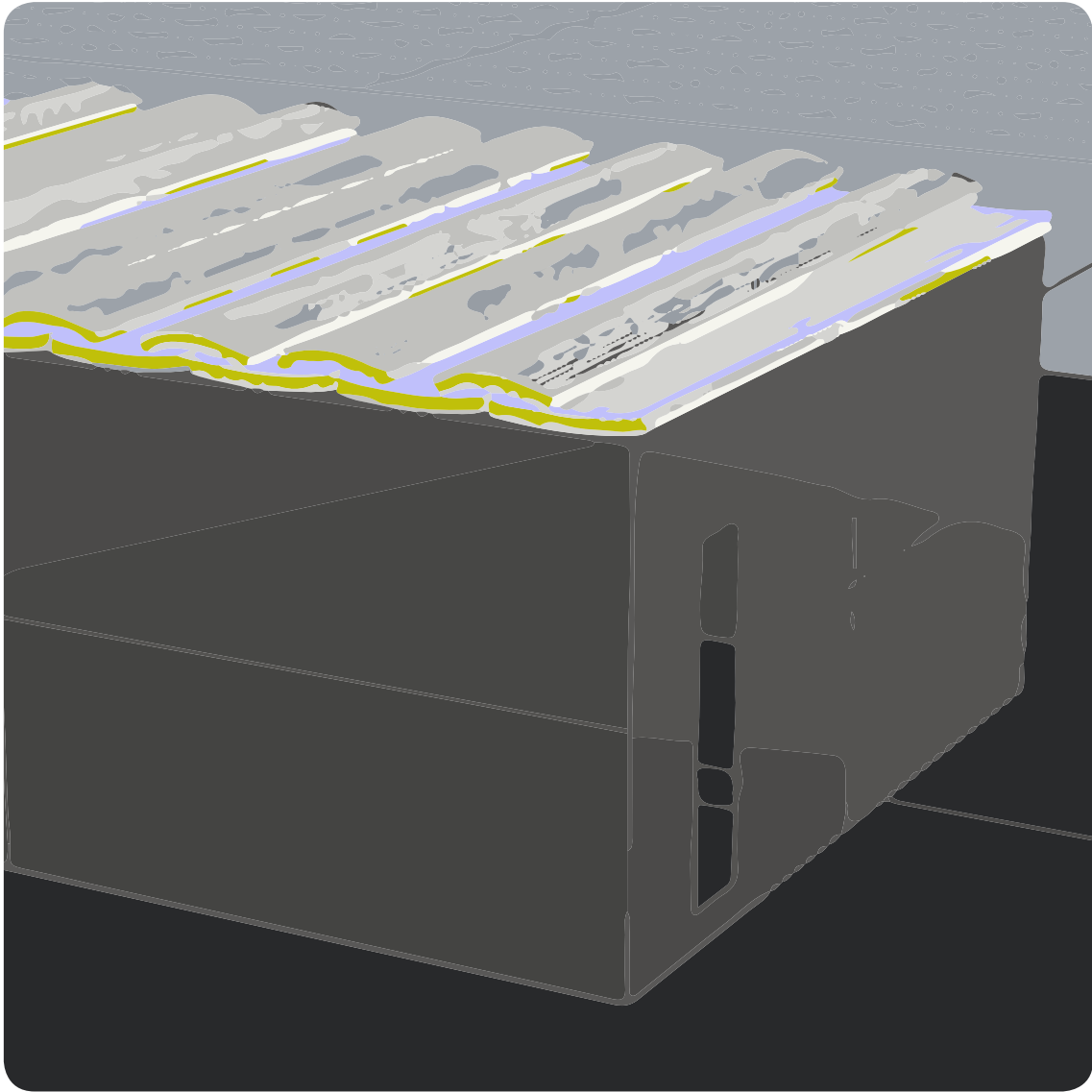

Roof Section

Sections could be mounted and overlapped laterally to create a roofing system. Turning and rotating these parts will create a water tight seal, preventing leakage.

Watertight, flip, connected, overlapping

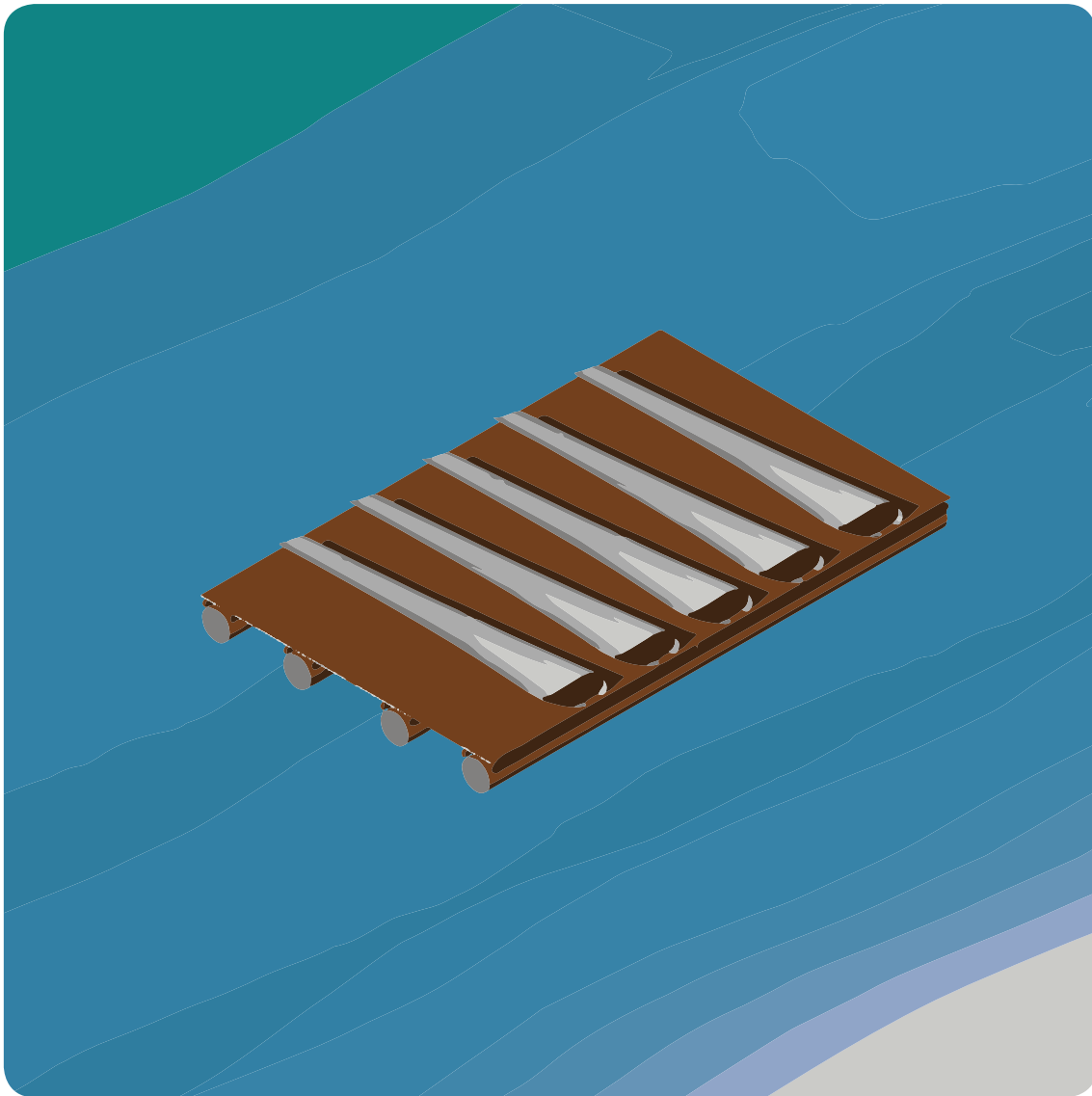

Pontoon

There is increasing interest around the world in floating offshore solar photovoltaic (pv) power. Placing solar panels on water (either inshore or offshore) has several attractive properties: Competition for other onshore land uses (agriculture, housing, industry, etc.) is eliminated.

Offshore pv plants are likely to have lower impacts on adjacent communities than onshore pv plants and may therefore be more socially acceptable.

**Floating, interwoven,
water resilience, inert,
electro transmittance**

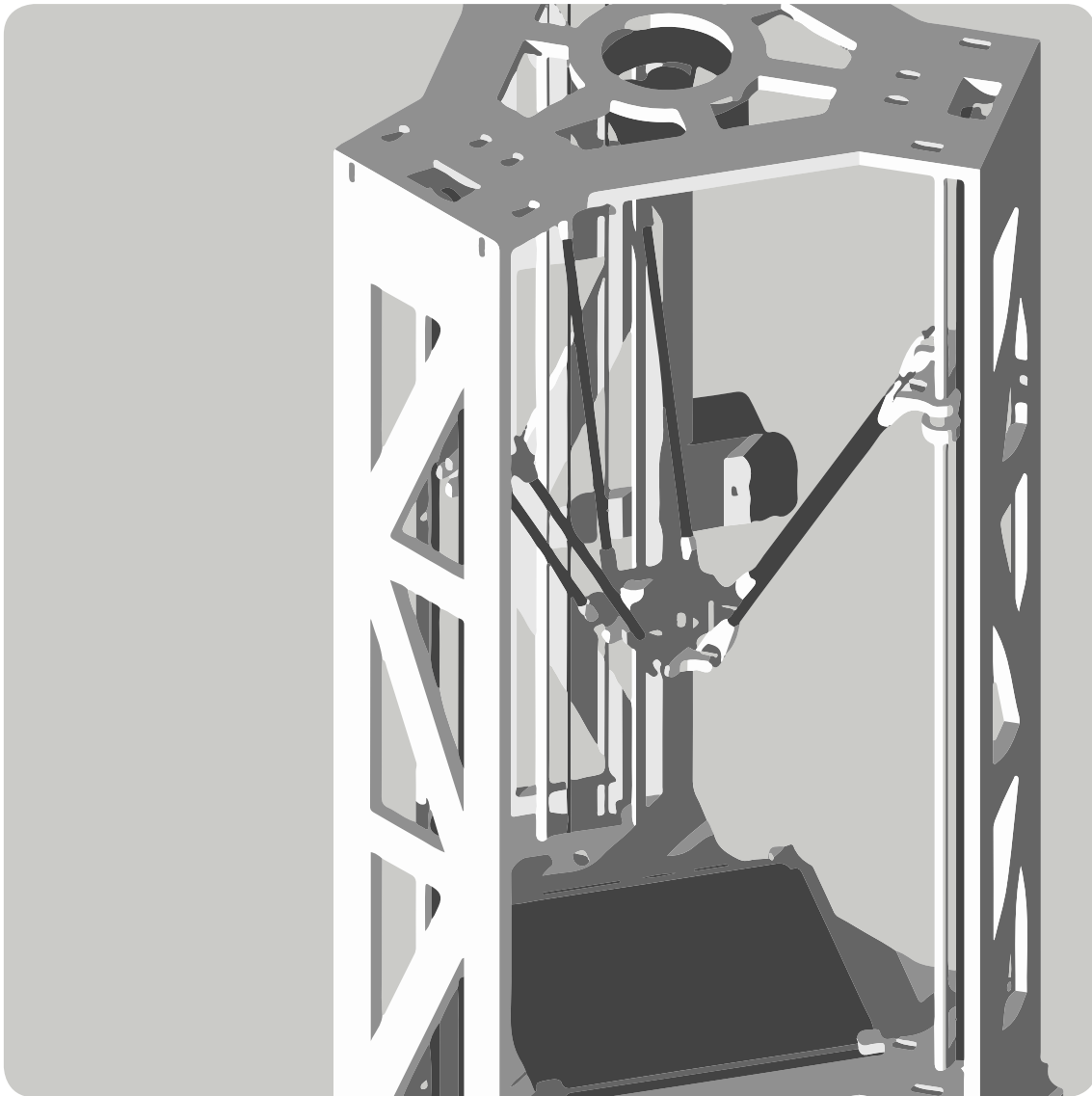

3D Pr- int Ma- terial

Micronisation, ink-jet printing, additive fabrication, binding material, free-form

Take the decommissioned wind blade and cut each member on site for easy transport to a local micronisation facility to be turned into a powder-like material. Once turned into a powdered substance, the material can be used across a range of powder bed ink-jet head 3D printers

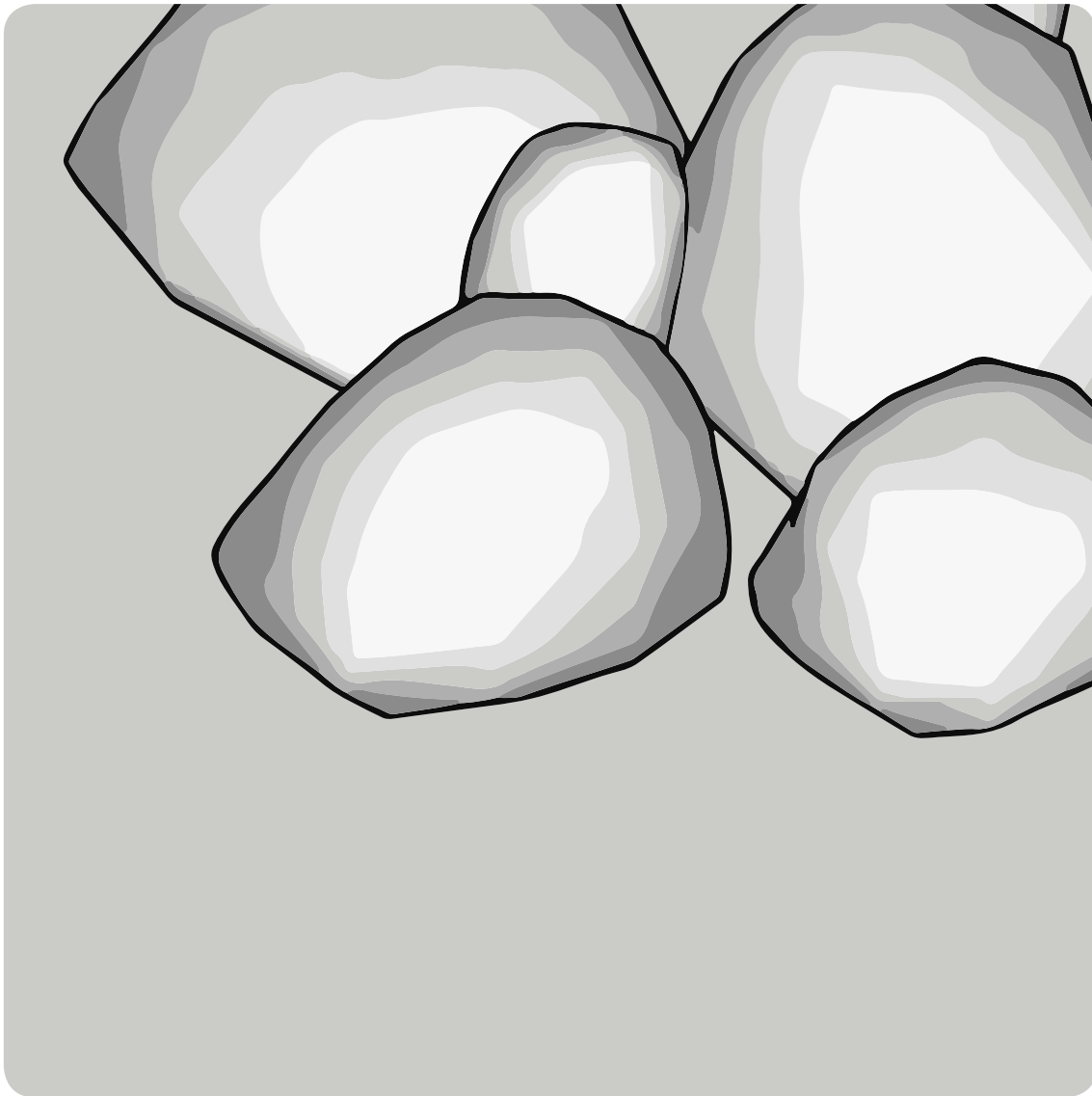

Aggregate

**Strength, abundance,
ratios, size of pieces,
lifespan**

Blade material from the solid composite parts could be cut up and used as a replacement for large (4 mm to 50 mm) natural aggregate for bound or unbound filler. Includes short bars for distributed reinforcement (needles).

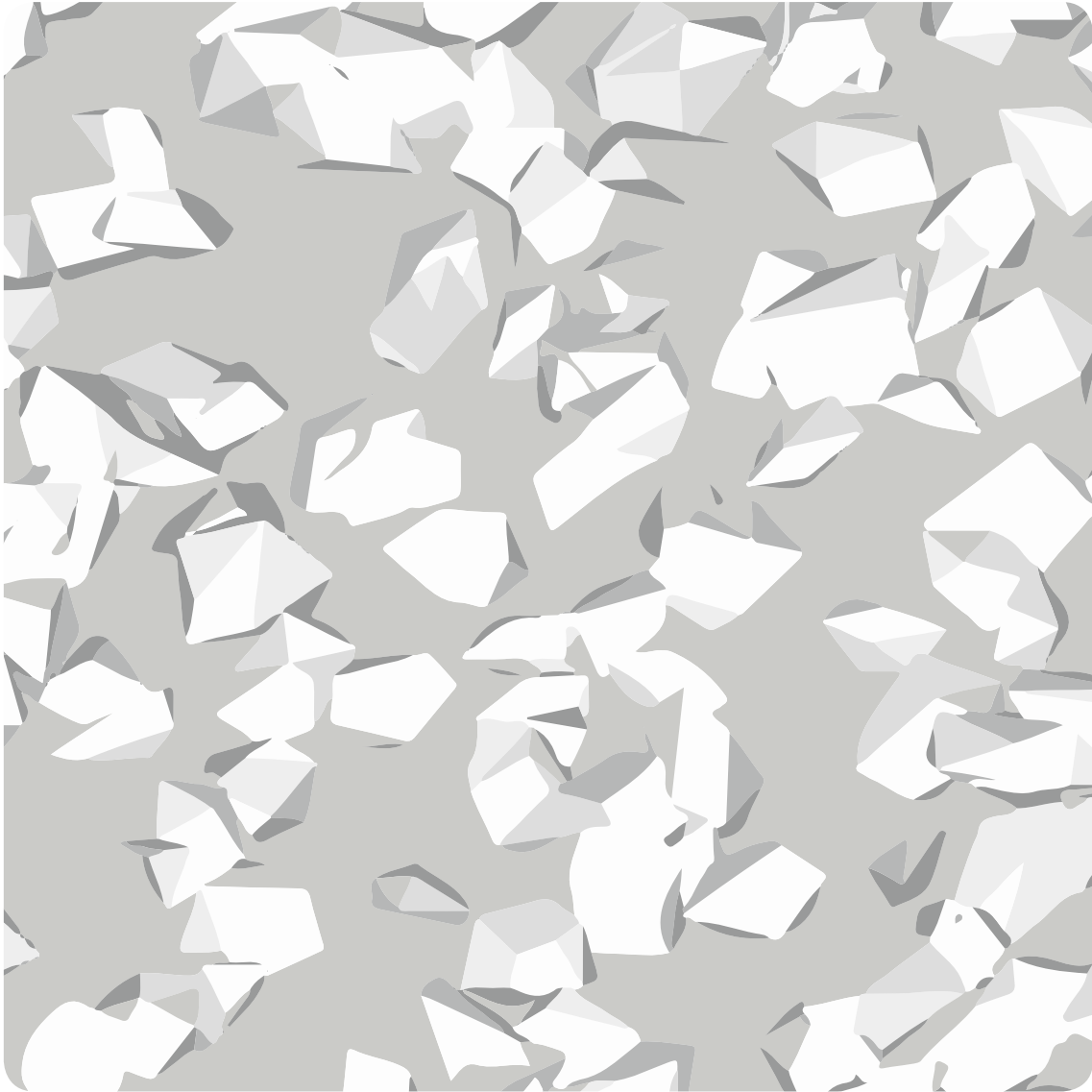

Filler

Blade material from the solid composite parts could be ground up to cut up and used as a replacement for natural aggregate for bound or unbound filler.

Strength, abundance, ratios, size of pieces, lifespan

More:

Reuse of wind turbine blade root segment for arch and pipe culverts

Wind turbine blades can significantly differ in their design and size. A large collection of wind turbine blades possesses a significant length of root segment which is straight and round. These could be used to create a series of root segments for pipe culverts.

Liquid or Granular Materials for farming

Flat shells are laid-down above ground and used as troughs to store liquids (such as water) and grain (such as feedstocks). Re-manufacturing needed to seal weep holes and ends and seat ends. Good for agriculture in rural communities.

Root Segment for Emergency Shelter

Large wind blades can have root diameter of up to 5.5m. The root segment of medium to large wind blades can be modified and used for emergency shelters.

Verticalising Landfills

Decommissioned Blades could be inserted into the ground around an existing landfill heap, to extend the height of the landfill and consequently the capacity. Blades could be overlapped to increase strength, and used to form a double ring around a current landfill. The inner part of the ring would be backfilled with support material.

Surfboards

Surfboards could possibly be made of the blades associated with other materials that are necessary to make it light and able to float.

Wind Attenuator

Full blades or long strips of blades would be embedded in the ground to create wind barriers for attenuating wind in rural or urban areas. (Like tress are used in landscape -- tennis courts etc.)

Artificial Reef

Sections of the blade would be submerged into the water and cluster together to form a reef which over time will support marine life.

Impact Attenuators

Composite material have very good energy absorption in certain directions. Large sections could be attached to concrete bridge piers in waterways for impact protection from ships. Or could be attached horizontally to docks to act as bumpers/fenders.

Furniture

The blade could be used to create a series of furniture elements simply by embracing the existing geometries, or cutting the blade down further and reassembling.

Playground Equipment

Given the property of the blade, these could be deployed outside to create a range of playground equipments.

Structural Concrete Fine Aggregate

Blade material from the solid composite parts could be ground up and used as a replacement for fine (less than 4 mm) natural aggregate for bound or unbound filler.

Unbound Road Base Course Aggregate

Blade material from the solid composite parts could be cut up and used as a replacement for natural aggregate for bound or unbound filler.

Reinforcing Bars for Concrete

Long strip cut for the solid composite materials in the spar caps and root areas could be used for internal reinforcement for non-critical concrete members (slabs on grade, curb and gutter)

Pedestal Foundations for Housing or other Construction

Large diameter (1m +) root section is place vertically in ground and used a platform for a small house or multiple sections are used as round piles for large footprint. Could also be used for non cylindrical parts (not the root) but needs more design. Similar to piles if small diameters.

Station Platforms

Full blades or long strips of blades would be embedded in the ground to create wind barriers for attenuating wind in rural or urban areas. (Like tress are used in landscape -- tennis courts etc.)

Shutters or Parts for Windows

Web parts are the only flat parts of the blade and could be used for may commodity items requiring flat sections. For housing can be used for doors and window shutters for permanent or temporary protection against wind/rain.

Fence and Perimeter Walls

Smaller sections could be crafted into interlocking perimeter pieces that could collective enclose various spaces.

Fibres for Clothing

During the grinding process, fibres could be created and used to weave into yarns to create technical fabrics.

Bio Battery

The turbine blade is hollow. An entire blade could be buried underground and filled up with biological waste to turn it into a long term bio battery, harvesting energy for grid use.

Art Installation

The raw material could be used in a variety of ways across a variety of disciplines from sculptors using medium to large sized pieces to create works or painters using the fibres and small pieces for texture and relief.

Aqueduct

Pieces could be used together to create small to medium scale aqueducts as a means of transporting water around allotment areas, gardens or parks.

Floating Farm

Blades fashioned together like a raft could serve a range of floating programmes such as a farm. Long profiles of the blade could be used to create troughs for plants and water storage areas.

Benches

Sections used to create benches and other public/private seating arrangements. Parts could cantilever.

Gateway

Blades stacked and spanning could create a threshold space for a range of applications including large scale events, conferences, parks etc.

Bus Shelter

Angled sections used to control rain downpour and create shielding from horizontal rain .

